

Parker CB Series Counterbalance Sandwich Valve Service Manual

General Description

Series CB counterbalance valve controls the actuator movement with overrunning loads.

The return flow from the actuator is piloted and controlled by the inlet flow to the actuator, ensuring a cavitation-free lowering of the load.

The counterbalance valve operates as a pressure relief valve. The setting pressure is lowered by the pressure in the inlet line. To ensure safe load holding the setting pressure should be approximately 30% higher than the max. load pressure.

Features

- Controlled movement loads.
- Load holding via leak-free poppet valve.
- Secondary relief protection for the actuator.
- Sizes:
 - CB03 – NFPA D03 / NG6 / CETOP 3
 - CB05 – NFPA D05 / NG10 / CETOP 5
 - CB5H – NFPA D05HE / NG10 / CETOP 5H
 - CB07 – NFPA D07 / NG16 / CETOP 7
 - CB08 – NFPA D08 / NG25 / CETOP 8

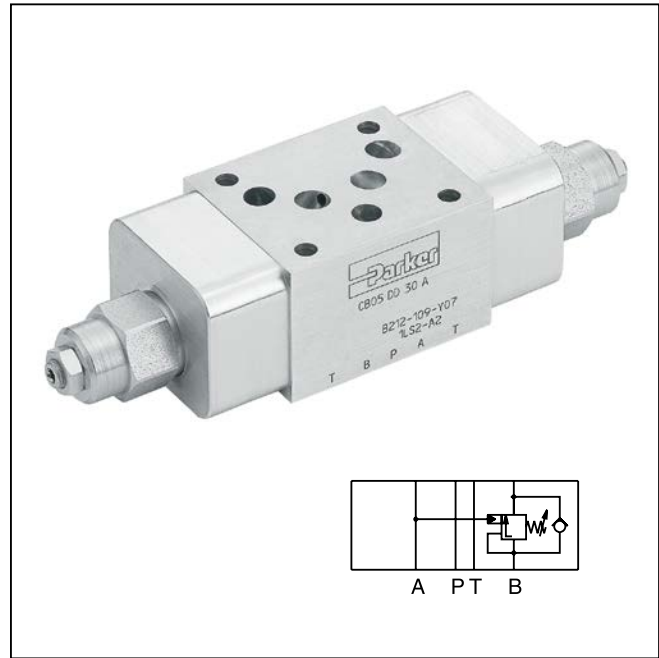

Specifications

General					
Size	D03 / NG6	D05 / NG10	D05HE / NG10	D07 / NG16	D08 / NG25
Mounting Position	Unrestricted				
Ambient Temperature Range	-20°C to +50°C (-4°F to +122°F)				
Hydraulic					
Maximum Operating Pressure*	Aluminum Body – up to 207 Bar (3000 PSI); Ductile Iron Body – up to 345 Bar (5000 PSI)				
Nominal Flow	57 LPM (15 GPM)	114 LPM (30 GPM)	114 LPM (30 GPM)	227 LPM (60 GPM)	454 LPM (120 GPM)
Leakage	5 DPM	5 DPM	5 DPM	5 DPM	5 DPM
Reseat Pressure	85% of set pressure				
Pilot Ratio	3:1	3:1	3:1	3:1	3:1
Adjustment Screw Hex Size	5/32	5/32	5/32	5/32	5/32
Fluid Temperature	-20°C to +80°C (-4°F to +176°F)				
Viscosity	Permitted	10 to 650 cSt / mm ² /s (46 to 3013 SSU)			
	Recommended	30 cSt / mm ² /s (139 SSU)			
Filtration	ISO Class 4406 (1999) 18/16/13 (acc. NAS 1638: 7)				

* Counterbalance valves should be set at least 1.3 times the maximum load induced pressure.

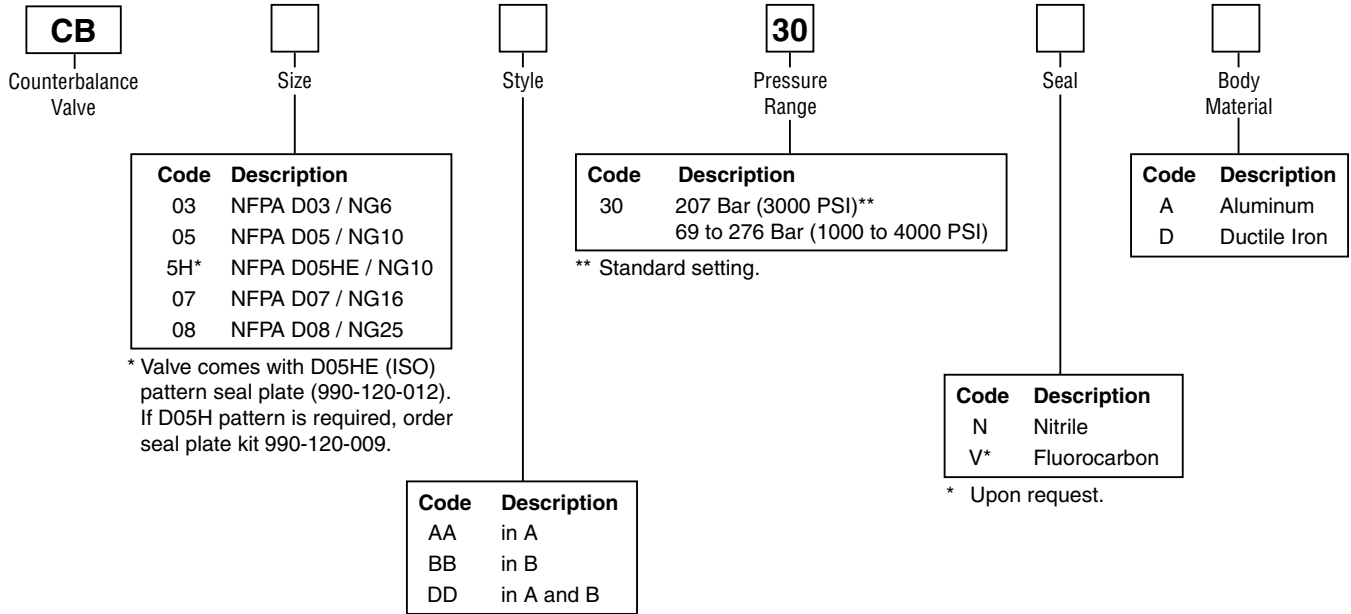

CBAA**

Counterbalance in A

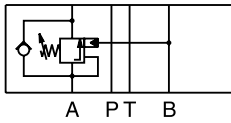

CBBB**

Counterbalance in B

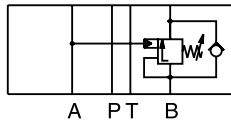

CBDD**

Counterbalance in A and B

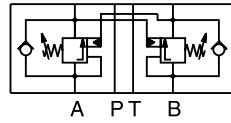

Weight:

Size	CB**AA30NA	CB**AA30ND	CB**BB30NA	CB**BB30ND	CB**DD30NA	CB**DD30ND
CB03	0.3 kg (0.8 lbs.)	1.1 kg (2.4 lbs.)	0.5 kg (1.1 lbs.)	1.1 kg (2.4 lbs.)	0.8 kg (1.7 lbs.)	1.5 kg (3.2 lbs.)
CB05, CB5H	1.0 kg (2.3 lbs.)	2.2 kg (4.9 lbs.)	1.0 kg (2.3 lbs.)	2.2 kg (4.9 lbs.)	1.5 kg (3.2 lbs.)	2.9 kg (6.4 lbs.)
CB07	2.5 kg (5.6 lbs.)	4.8 kg (10.6 lbs.)	2.5 kg (5.5 lbs.)	5.3 kg (11.8 lbs.)	3.6 kg (8 lbs.)	7.3 kg (16.2 lbs.)
CB08	5.3 kg (11.7 lbs.)	11.8 kg (25.9 lbs.)	5.9 kg (13.1 lbs.)	13.3 kg (29.3 lbs.)	7.9 kg (17.4 lbs.)	16.2 kg (35.8 lbs.)

CB03*

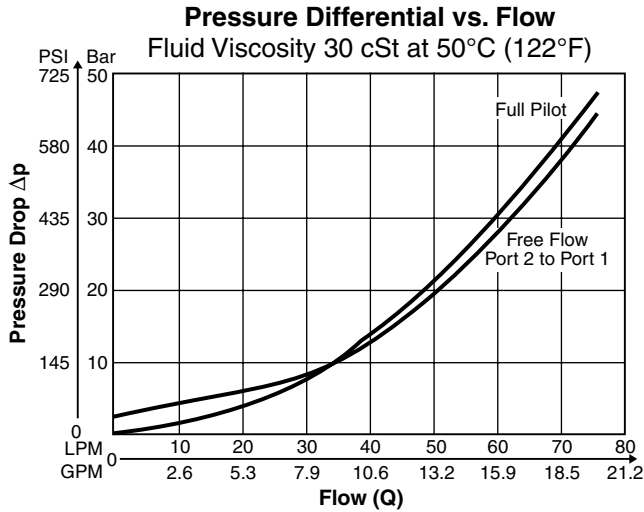

CB05/CB5H

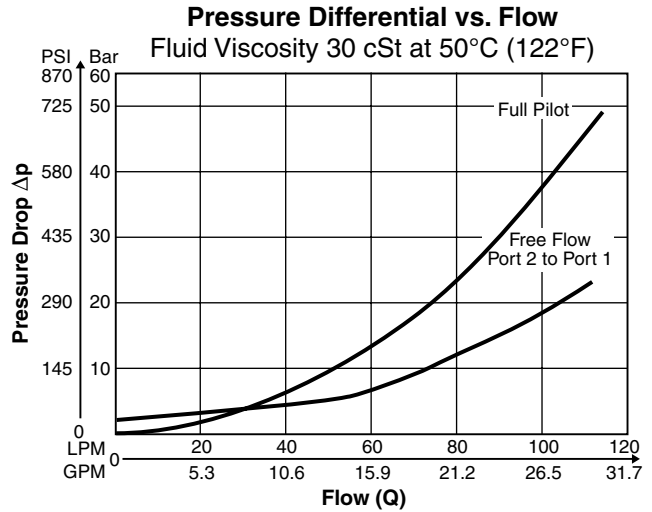

CB03*

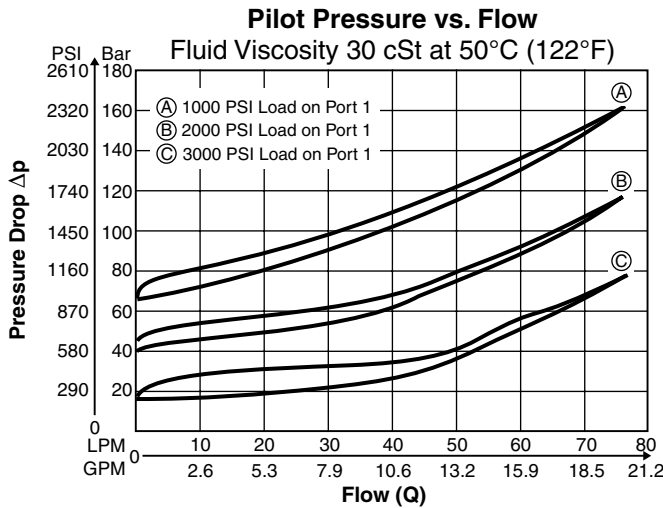

CB05/CB5H

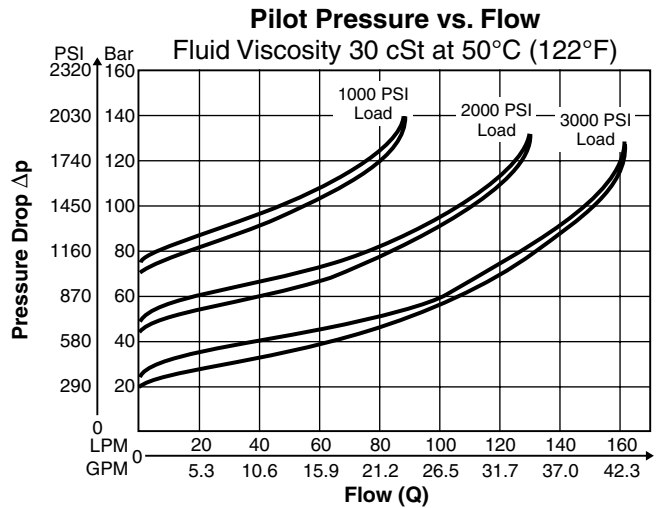

CB03*

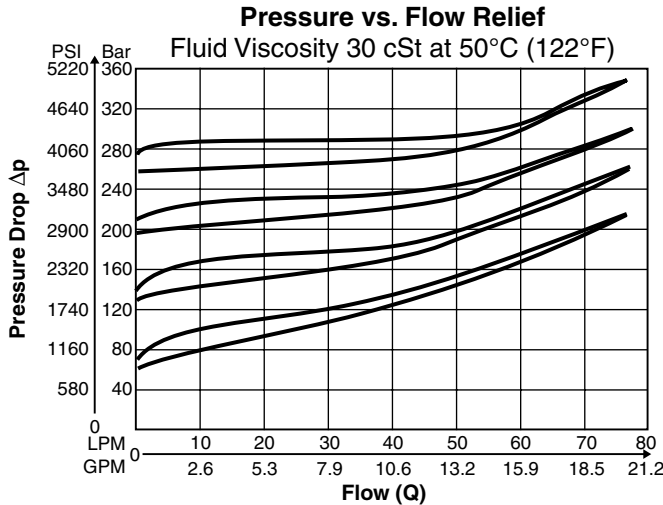

CB05/CB5H

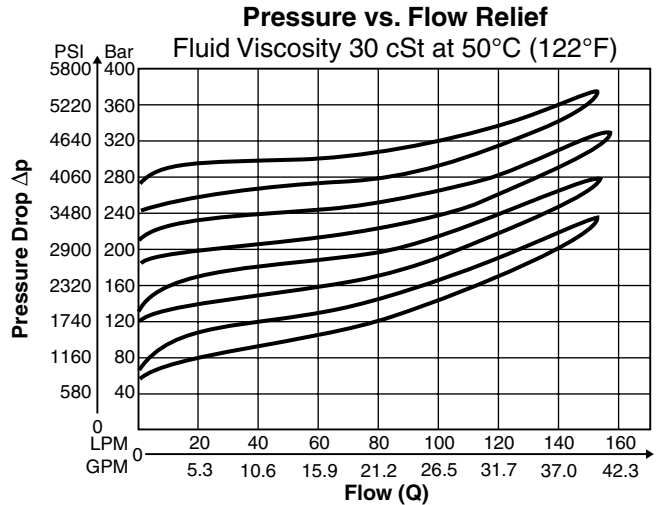

CB07*

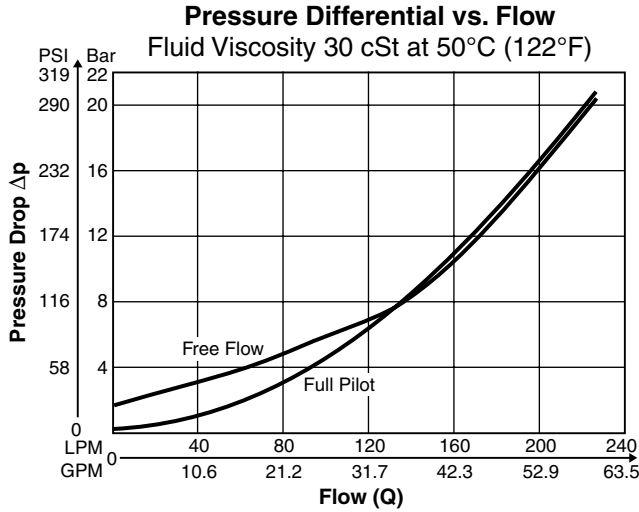

CB08*

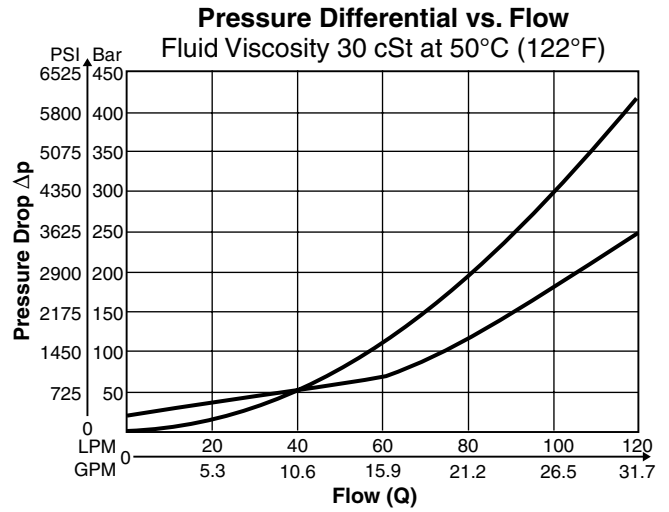

CB07*

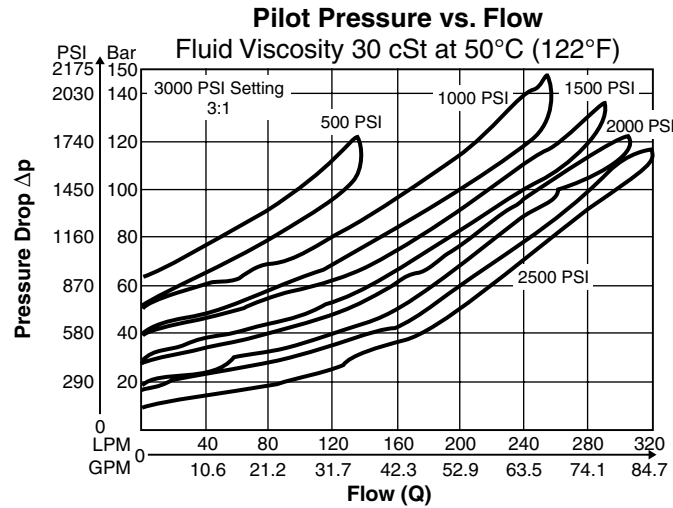

CB08*

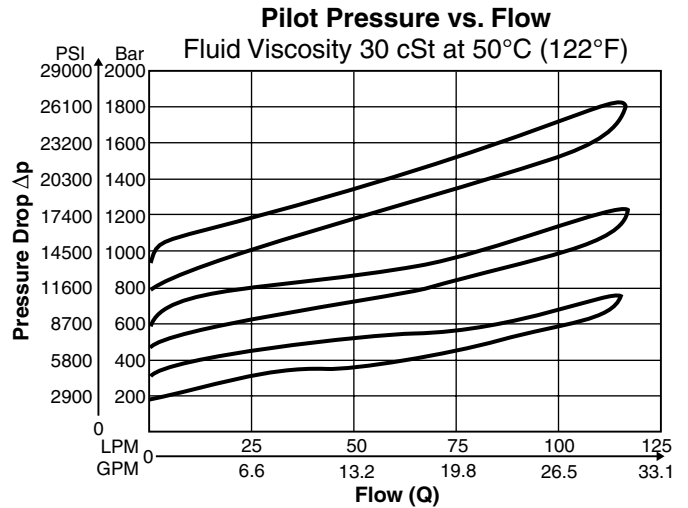

CB07*

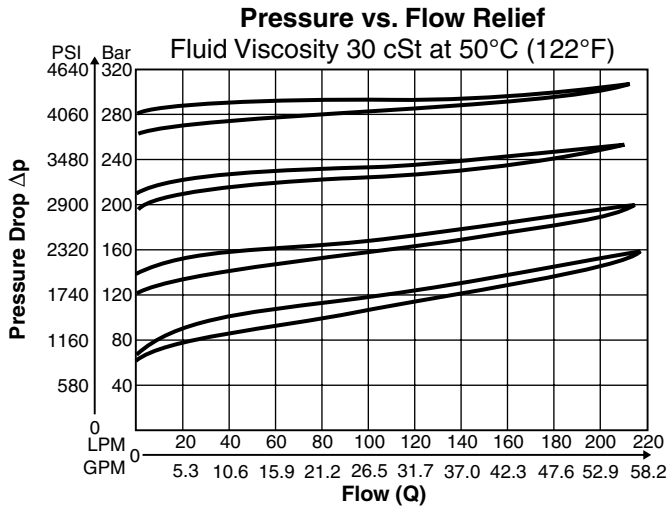

CB08*

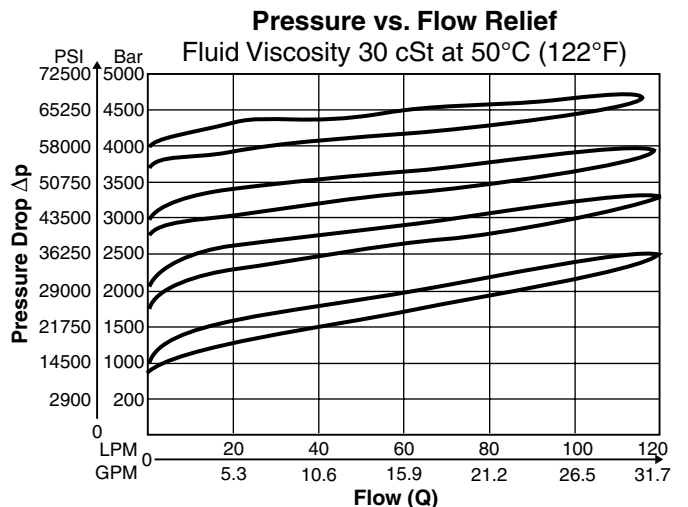

CB03AA – Inch equivalents for millimeter dimensions are shown in (**)

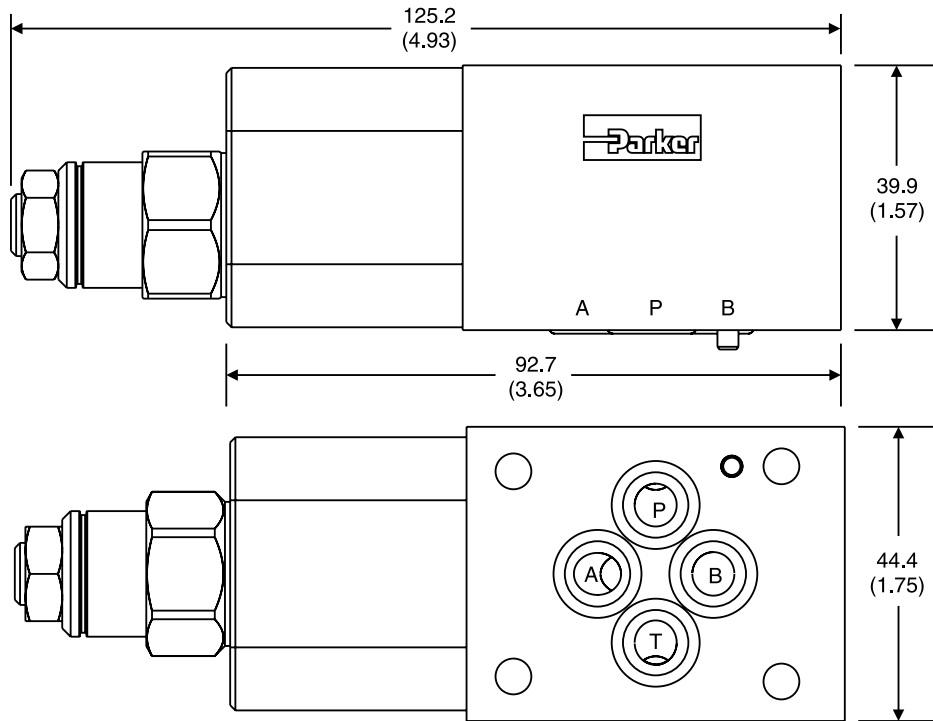

CB03BB – Inch equivalents for millimeter dimensions are shown in (**)

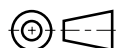
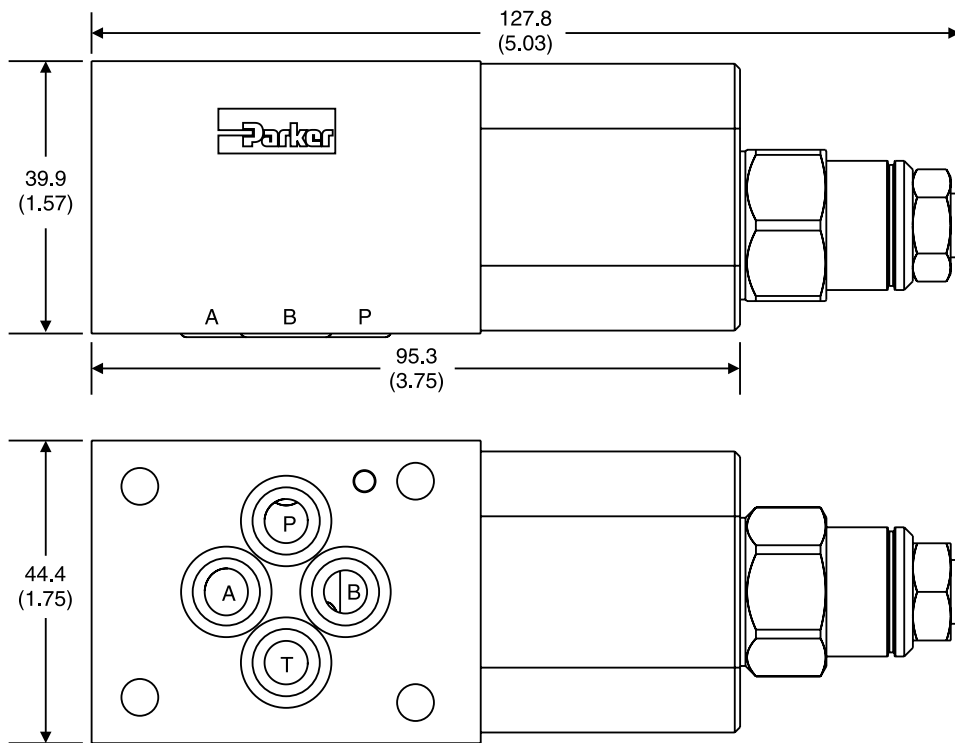

Dimensions

Series CB

CB03DD – Inch equivalents for millimeter dimensions are shown in (**)

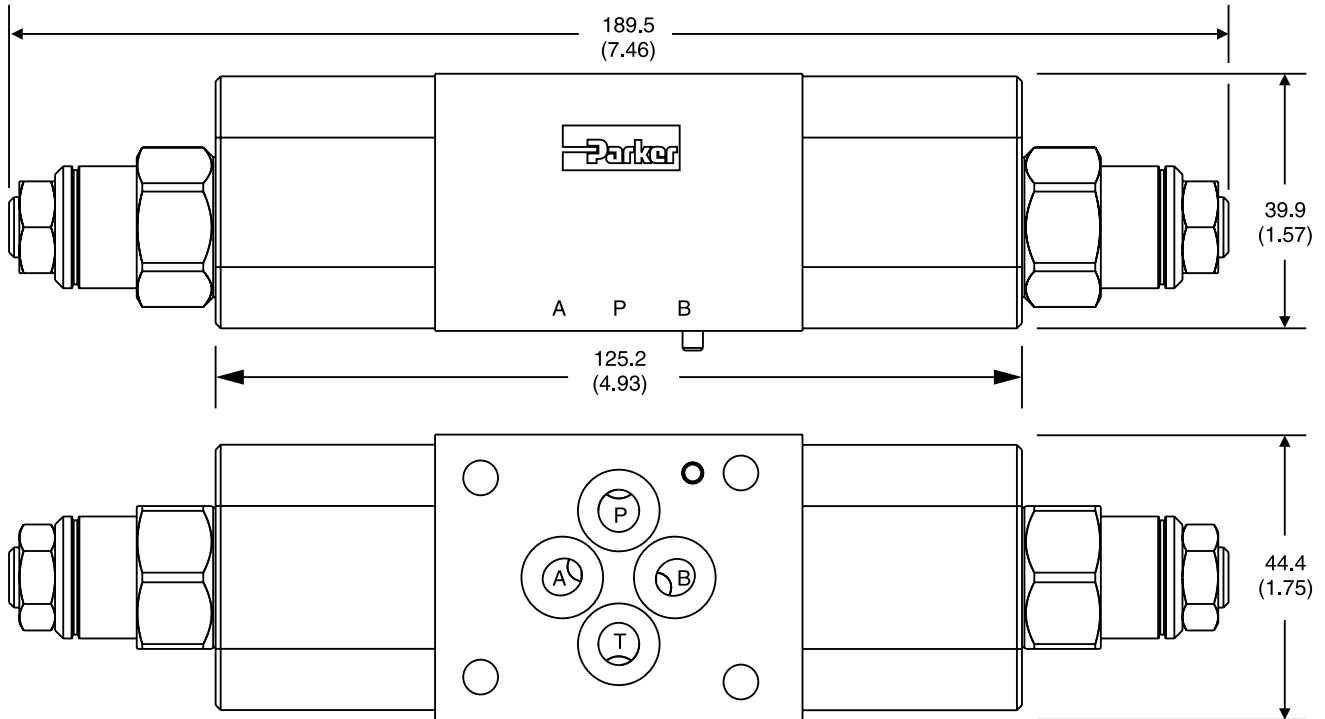

CB05AA – Inch equivalents for millimeter dimensions are shown in (**)

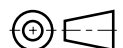
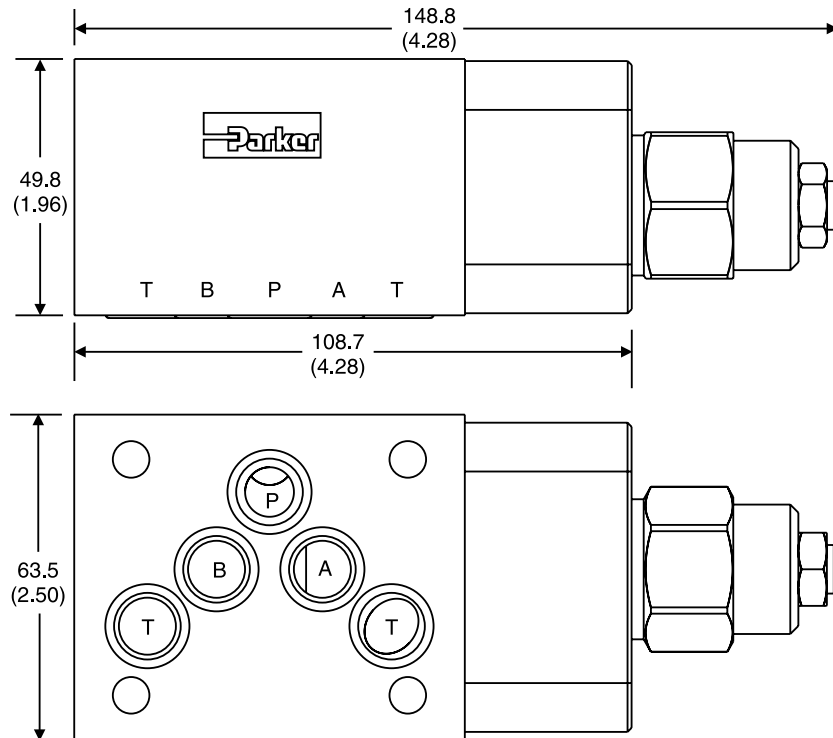

CB05BB – Inch equivalents for millimeter dimensions are shown in (**)

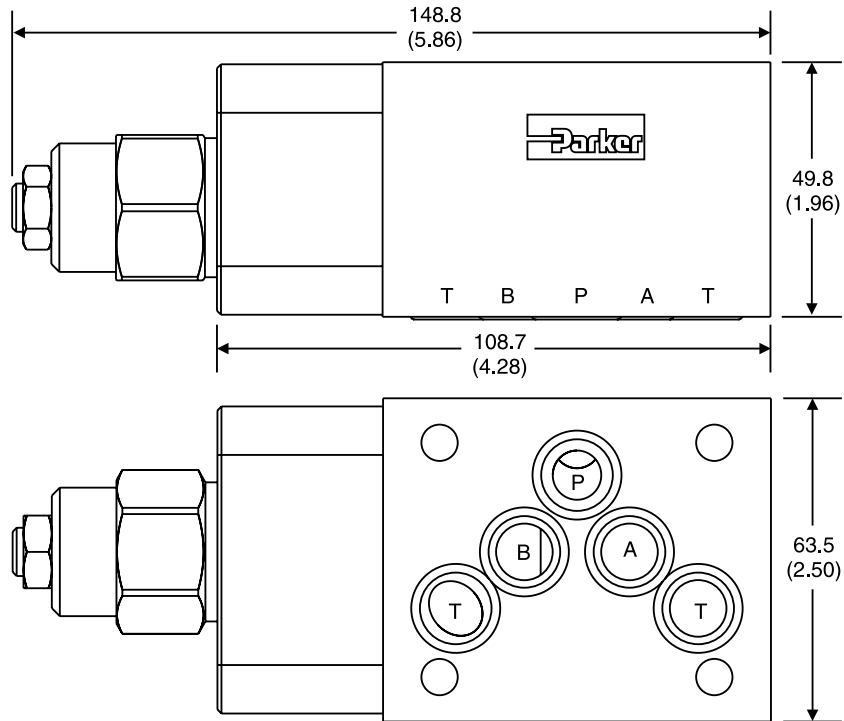

CB05DD – Inch equivalents for millimeter dimensions are shown in (**)

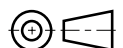
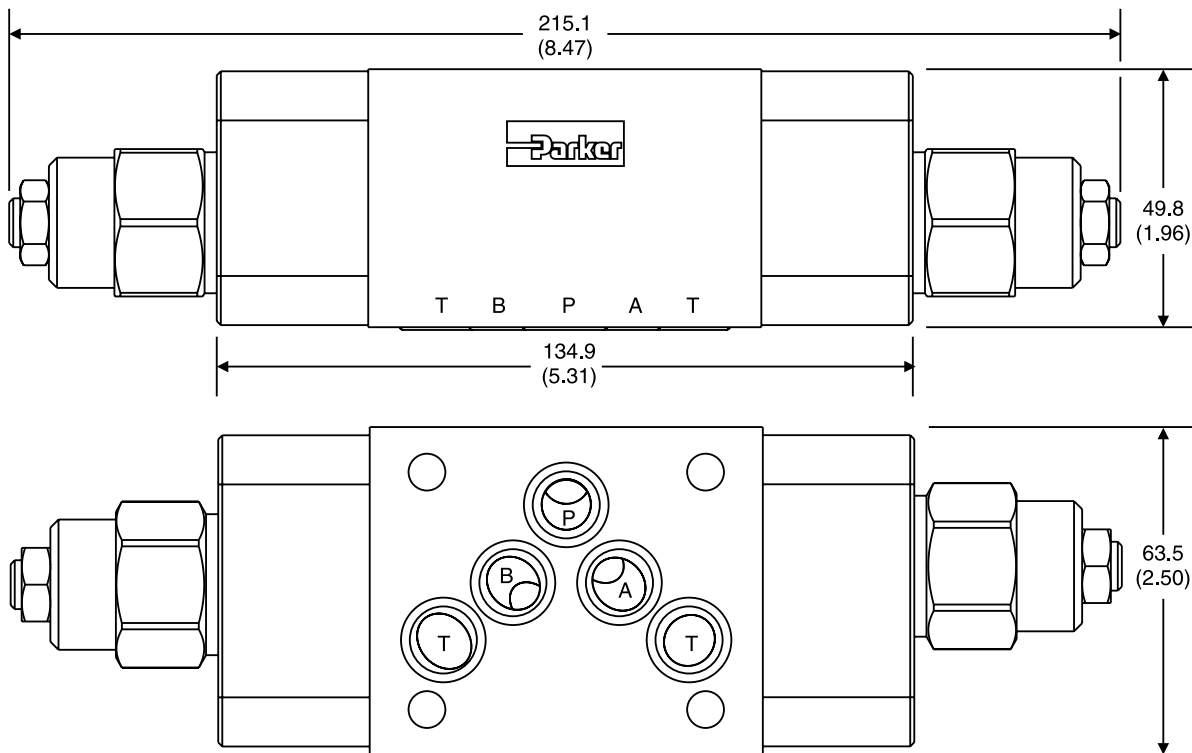

Dimensions

CB5HAA – Inch equivalents for millimeter dimensions are shown in (**)

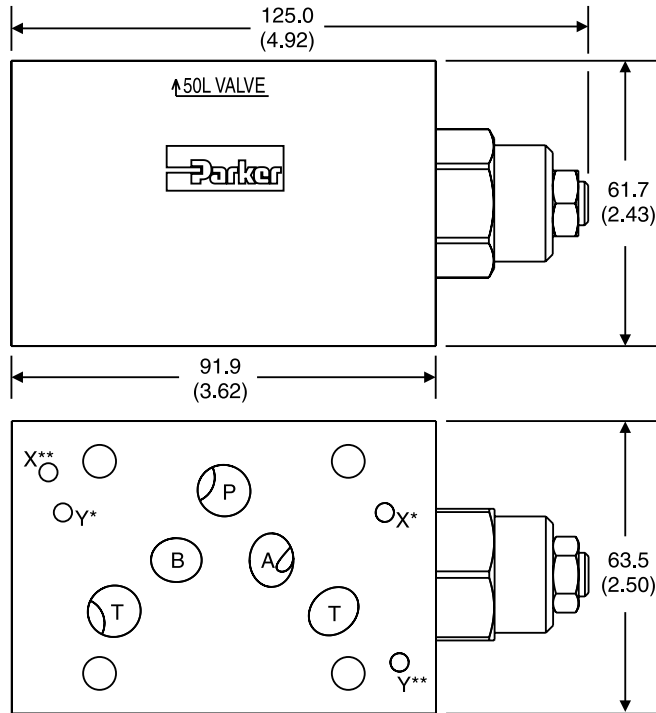

Valve comes with D05HE (ISO) Pattern seal plate (990-120-012). If D05H pattern is required, order seal plate kit 990-120-009.

- * D05HE (Standard)
- ** D05H

CB5HBB – Inch equivalents for millimeter dimensions are shown in (**)

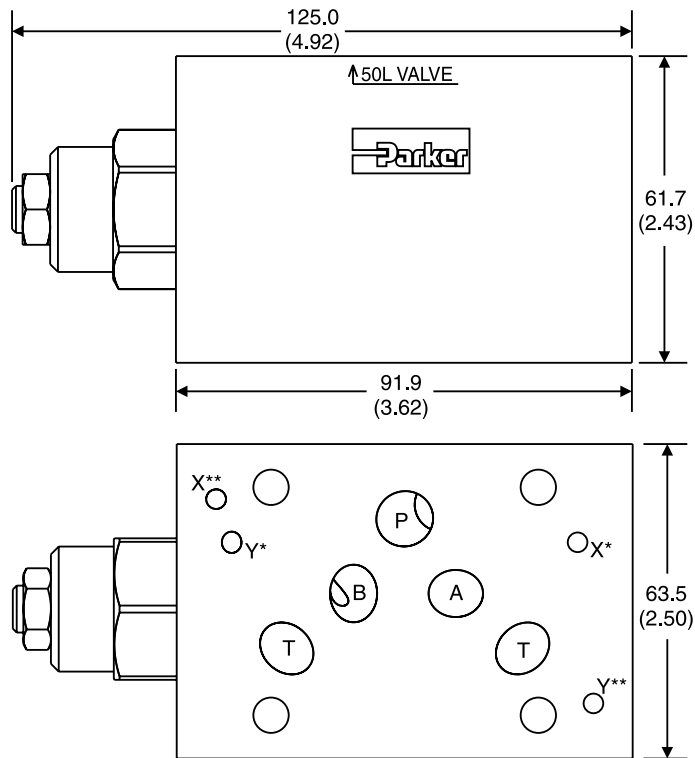

Valve comes with D05HE (ISO) Pattern seal plate (990-120-012). If D05H pattern is required, order seal plate kit 990-120-009.

- * D05HE (Standard)
- ** D05H



Dimensions

CB5HDD – Inch equivalents for millimeter dimensions are shown in (**)

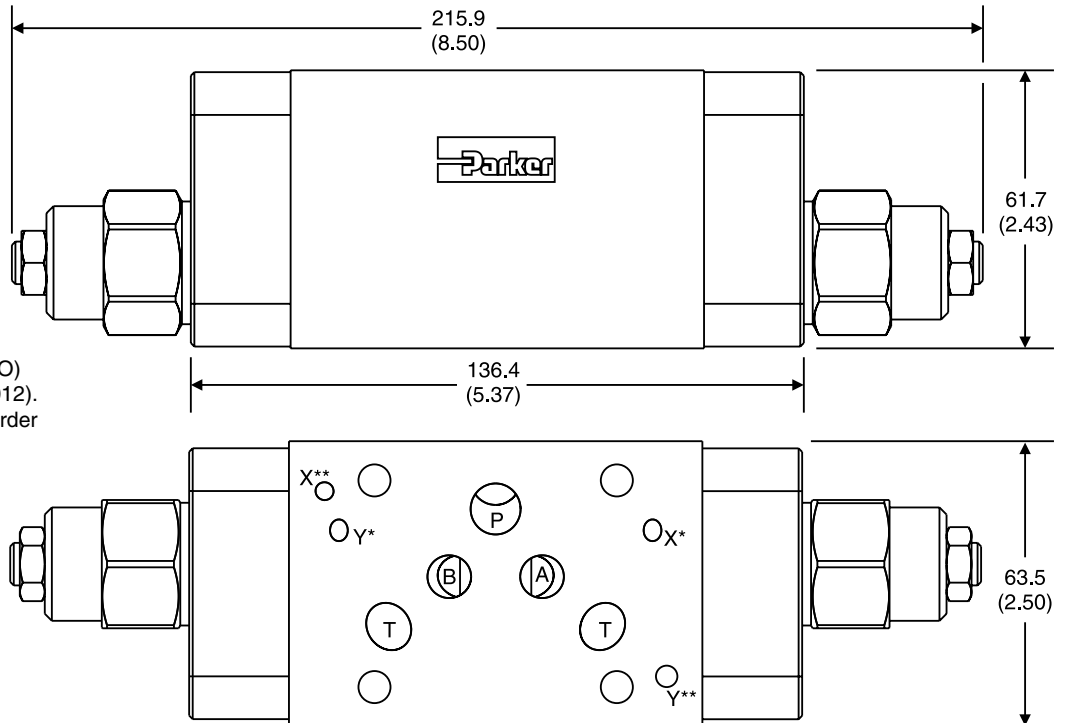

Valve comes with D05HE (ISO) Pattern seal plate (990-120-012). If D05H pattern is required, order seal plate kit 990-120-009.

- * D05HE (Standard)
- ** D05H

CB07AA – Inch equivalents for millimeter dimensions are shown in (**)

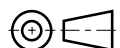
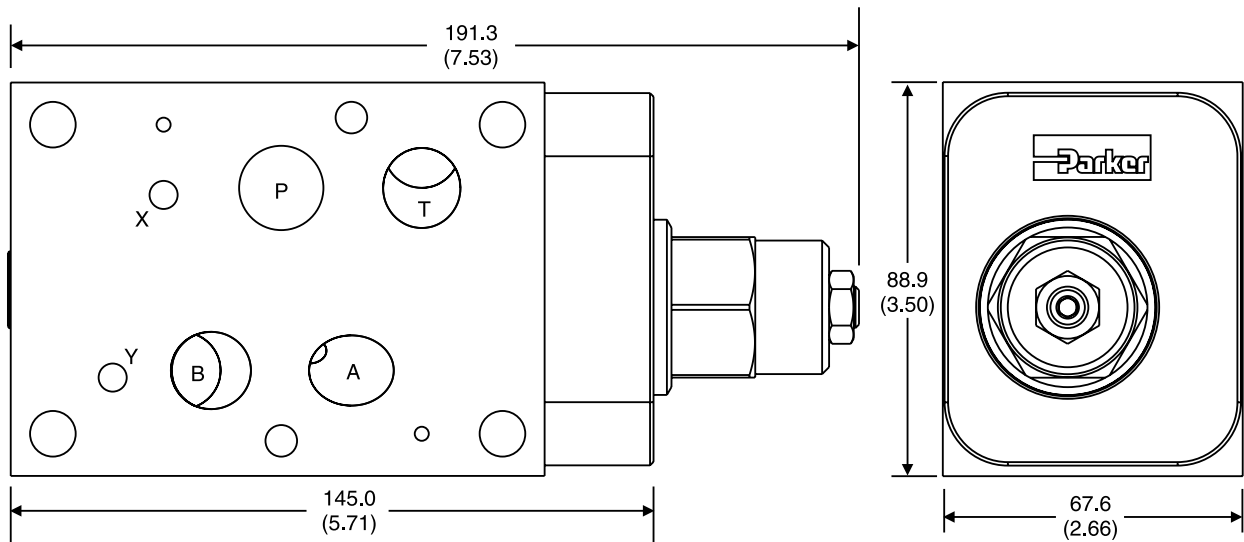

Dimensions

CB07BB – Inch equivalents for millimeter dimensions are shown in (**)

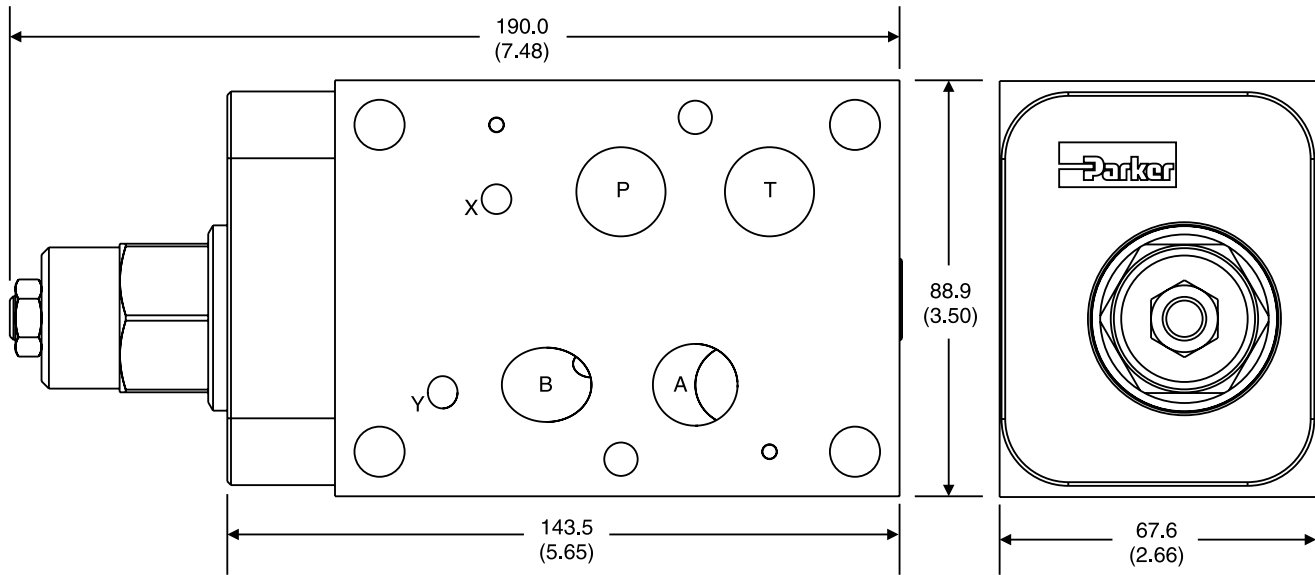

CB07DD – Inch equivalents for millimeter dimensions are shown in (**)

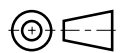
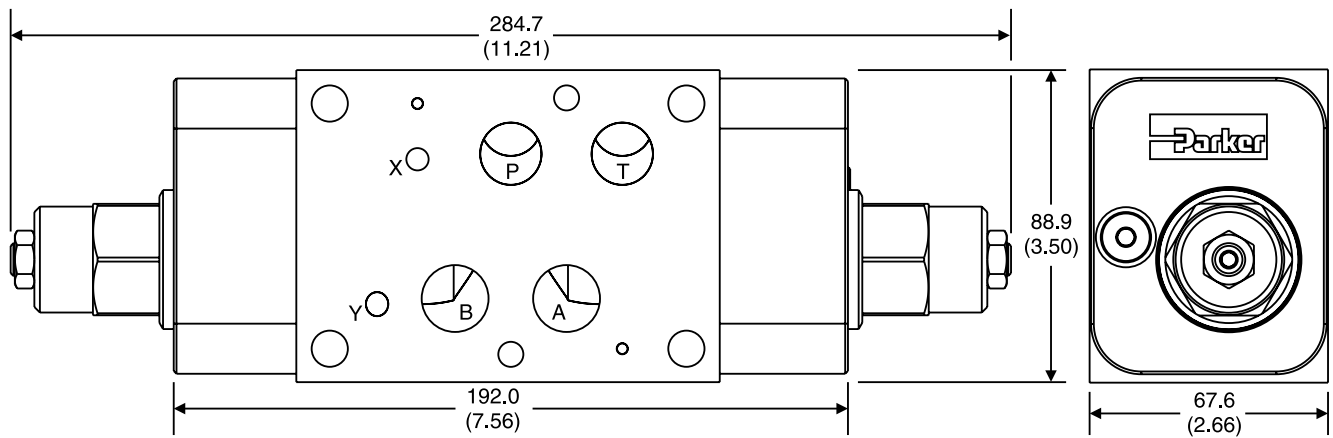

CB08AA – Inch equivalents for millimeter dimensions are shown in (**)

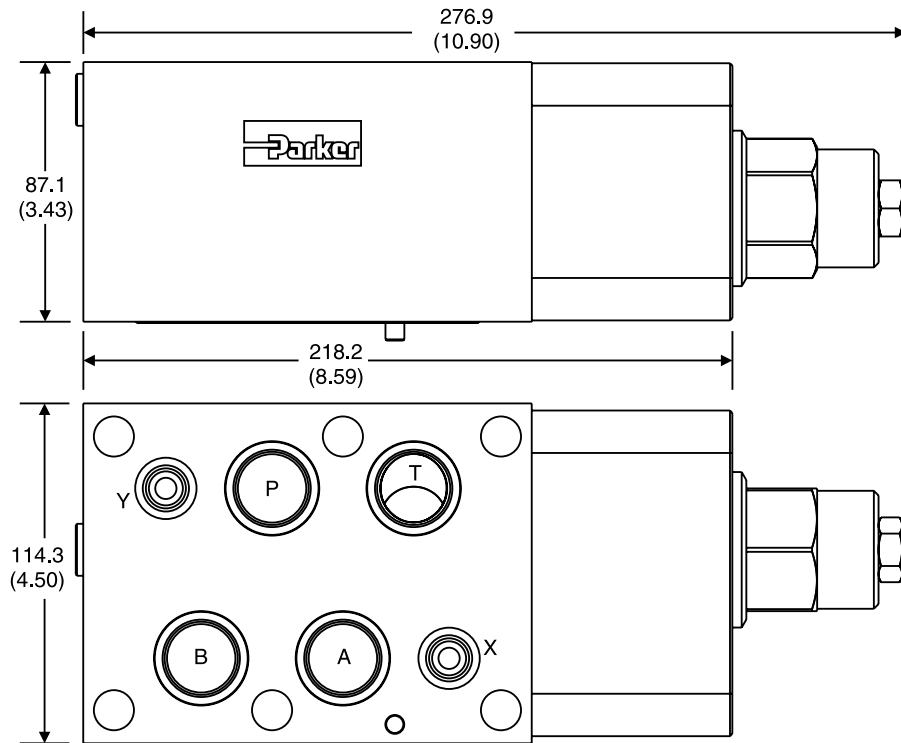

CB08BB – Inch equivalents for millimeter dimensions are shown in (**)

