

# Parker Series D1SE 32 Way Seated Type Directional Control Valve Service Manual

2

The directional valve type D1SE is equipped with a wet pin armature solenoid, drain free poppet and compatible with the standards DIN NG06, CETOP 03, and NFPA D03. Due to the 3/2-way design, port A is either connected with P or discharged in the tank. The neutral position (solenoid not activated) is taken automatically by a return spring. This position remains until the solenoid is energized.

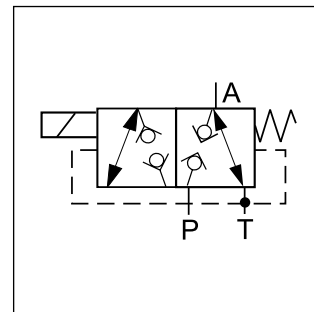

The valve poppet including activation lever and the armature of the solenoid are located in the pressurized oil chamber of connection T. The valve poppet is designed such that there can be no differential area in its axial operational direction (opening, closing). Thus it is statically pressure-balanced so that the valve can be switched in both flow directions even under pressure.

The unit has an all-steel design, the important functional inner parts are hardened, the poppet and seat are grinded.

## Ordering code

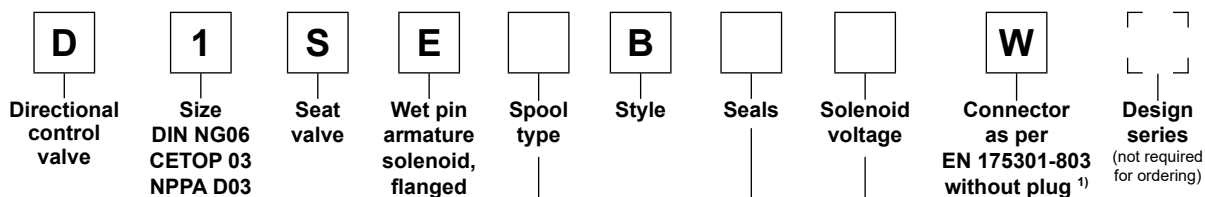

| Code      | Spool type |
|-----------|------------|
| <b>30</b> |            |
| <b>83</b> |            |

| Code            | Voltage |
|-----------------|---------|
| <b>K</b>        | 12 V=   |
| <b>J</b>        | 24 V=   |
| U <sup>2)</sup> | 98 V=   |
| G <sup>2)</sup> | 205 V=  |

| Code     | Seals      |
|----------|------------|
| <b>N</b> | <b>NBR</b> |
| V        | FPM        |

**Bold letters = Short-term availability**

## Solenoids for repair

| Voltage | Ordering code   |
|---------|-----------------|
| 12 V=   | 7329700 - 12 V  |
| 24 V=   | 7329700 - 24 V  |
| 98 V=   | 7329700 - 98 V  |
| 205 V=  | 7329700 - 205 V |

<sup>1)</sup> Please order plug separately.

<sup>2)</sup> To be used in combination with rectifier plugs at 120 VAC / 230 VAC power supply.

**Technical Data / Characteristic Curves**

2

| General  |   |        |        |        |         |
|--|---|--------|--------|--------|---------|
| Design   | Directional poppet valve  |        |        |        |         |
| Actuation  | Solenoid  |        |        |        |         |
| Size   | DIN NG6 / CETOP 03 / NFPA D03   |        |        |        |         |
| Mounting interface                                 | DIN 24340 A6 / ISO 4401 / CETOP RP 121-H / NFPA D03                         |        |        |        |         |
| Mounting position                                  | Unrestricted, preferably horizontal   |        |        |        |         |
| Ambient temperature [°C]                           | -25...+60, observe permissible duty cycle                                   |        |        |        |         |
| MTTF <sub>D</sub> value [years]                    | 150   |        |        |        |         |
| Weight [kg]  | 1.5   |        |        |        |         |
| Hydraulic  |   |        |        |        |         |
| Max. operating pressure [bar]                      | P, A, T: 350  |        |        |        |         |
| Fluid  | Hydraulic oil according to DIN 51524  |        |        |        |         |
| Fluid temperature [°C]                             | -20...+60 (NBR: -25...+70)  |        |        |        |         |
| Viscosity permitted [cSt] / [mm <sup>2</sup> /s]   | 10...500  |        |        |        |         |
| Viscosity recommended [cSt] / [mm <sup>2</sup> /s] | 30...80   |        |        |        |         |
| Filtration   | ISO 4406 (1999); 18/16/13   |        |        |        |         |
| Flow max. [l/min]                                  | 20  |        |        |        |         |
| Static / Dynamic                                   |   |        |        |        |         |
| Step response [ms]                                 | Energized: approx. 50   |        |        |        |         |
|  | De-energized: approx. 60  |        |        |        |         |
| Electrical characteristics                         |   |        |        |        |         |
| Duty ratio   | See diagram   |        |        |        |         |
| Max. switching frequency [1/h]                     | 2000  |        |        |        |         |
| Protection class                                   | IP65 in accordance with EN 60529 (with correctly mounted plug-in connector) |        |        |        |         |
|  | Code  | K      | J      | U      | G       |
| Supply voltage [V]                                 |   | 12 V = | 24 V = | 98 V = | 205 V = |
| Tolerance supply voltage [%]                       |   | ±10    | ±10    | ±10    | ±10     |
| Current consumption [A]                            |   | 1.95   | 1.1    | 0.25   | 0.13    |
| Power consumption [W]                              |   | 23.4   | 26.4   | 24.3   | 26.6    |
| Solenoid connection                                | Connector as per EN 175301-803  |        |        |        |         |
| Wiring min. [mm <sup>2</sup> ]                     | 3 x 1.5 recommended   |        |        |        |         |
| Wiring length max. [m]                             | 50 recommended  |        |        |        |         |

With electrical connections the protective conductor (PE  $\perp$ ) must be connected according to the relevant regulations.

**Performance curve  $\Delta p$ -Q**

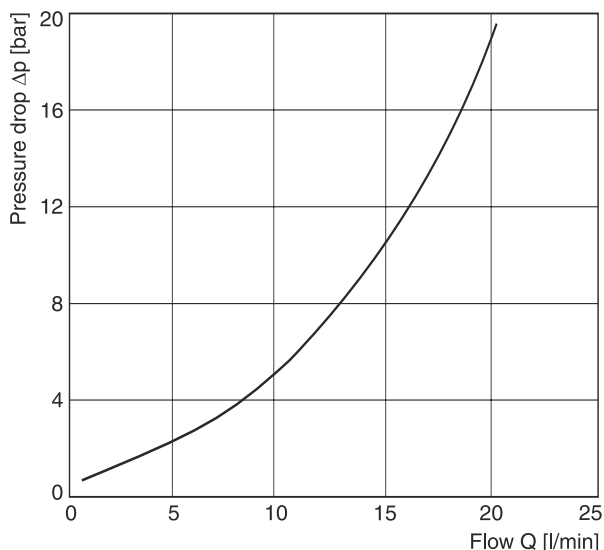

**Duty cycle versus ambient temperature**

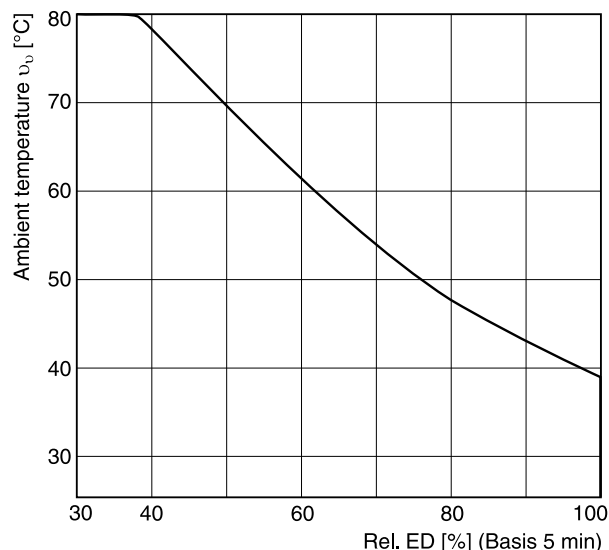



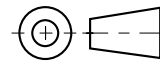
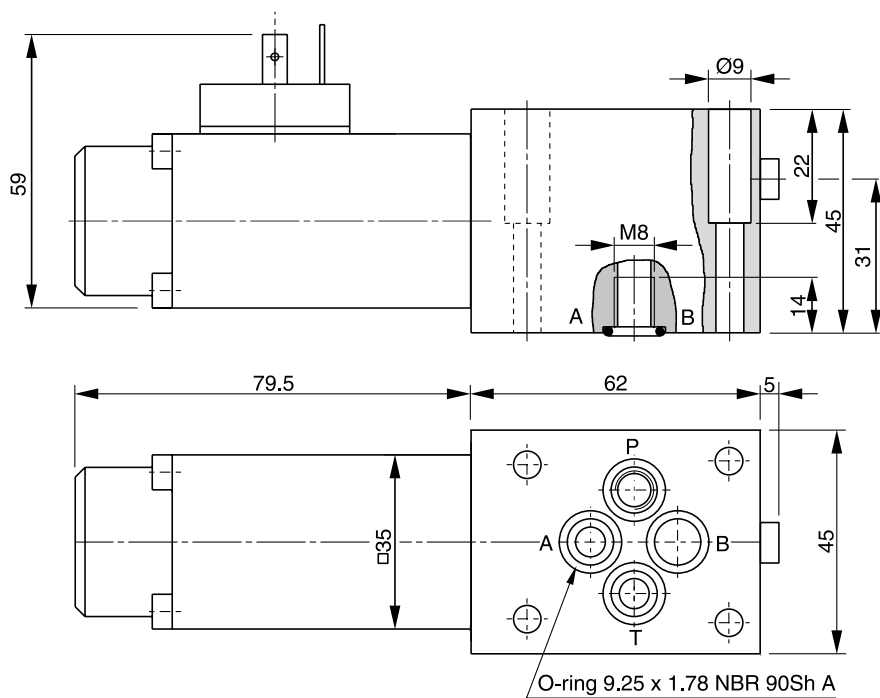

All characteristic curves measured with HLP46 at 50 °C.

## Dimensions

2

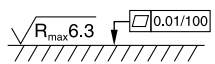

| Surface finish  |  Kit |  Kit |  Kit |  Kit |
|---|---|---|--|---|
|  | BK375   | 4x M5x30<br>ISO 4762-12.9   | 7.6 Nm<br>±15 %  | <b>NBR: SK-D1SE-70</b><br>FPM: DK-D1SE-V70  |

Subplates and manifolds see chapter 12.

The space necessary to remove the plug per EN 175301-803, design type AF is at least 15 mm.  
The torque for the screw M3 of the plug has to be 0.5 to 0.6 Nm.