

Parker Series D3W Directional Control Valve with Inductive Position Control

The direct operated valves series D3W with inductive position control are typically used in safety relevant applications. The start or the end position can be monitored.

The fail-safe position of the directional valve during power failure is the spring offset position.

2 Please find detailed information on the machine directive in the position paper in chapter 1.

Attention:

The adjustment of the position control is factory set and sealed. Replacement and repairs can only be undertaken by the manufacturer.



D3W*B



D3W*C

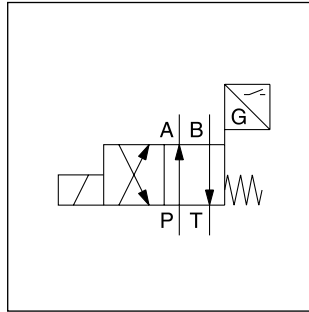

D3W*B

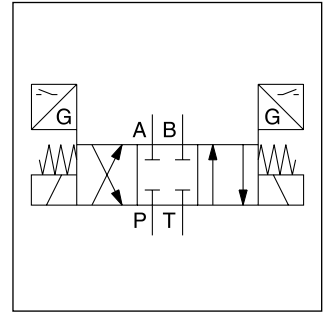

D3W*C

D3W*B

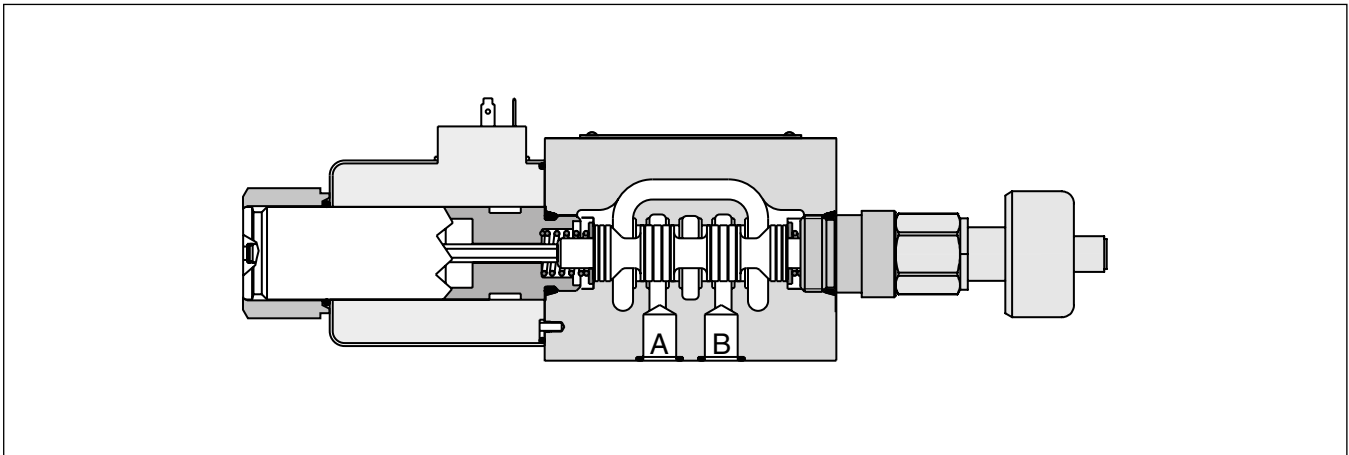

D3W*C

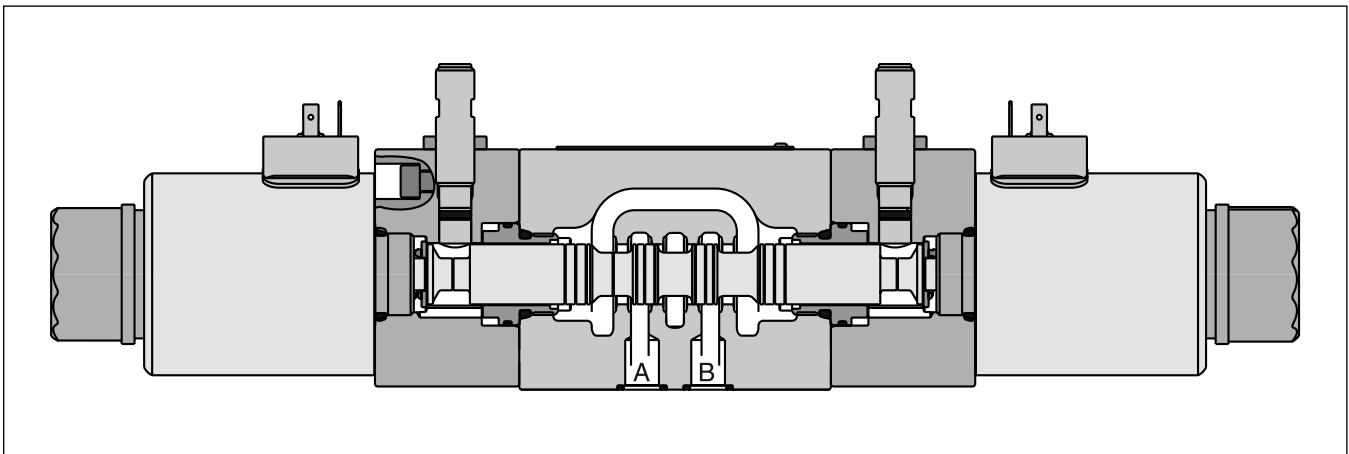

General					
Design	Directional spool valve				
Actuation	Solenoid				
Size	DIN NG10 / CETOP 05 / NFPA D05				
Mounting interface	DIN 24340 A10 / ISO 4401 / CETOP RP 121-H / NFPA D05				
Mounting position	unrestricted, preferably horizontal				
Ambient temperature	[°C]	-20...+60			
MTTF _D value	[years]	150			
Weight	[kg]	5.2			
Hydraulic					
Max. operating pressure	[bar]	P, A, B: 350; T: 210			
Fluid	Hydraulic oil according to DIN 51524				
Fluid temperature	[°C]	-20 ... +70			
Viscosity permitted	[cSt] / [mm ² /s]	2.8...400			
Viscosity recommended	[cSt] / [mm ² /s]	30...80			
Filtration	ISO 4406 (1999); 18/16/13				
Flow max.	[l/min]	150 (see shift limits)			
Leakage at 50 bar	[ml/min]	Up to 20 per flow path, depending on spool			
Static / Dynamic					
Step response at 95 %	Energized: 105; de-energized: 85				
Electrical characteristics					
Duty ratio	100 % ED; CAUTION: coil temperature up to 150 °C possible				
Max. switching frequency	[1/h]	10000			
Protection class	IP65 in accordance with EN 60529 (with correctly mounted plug-in connector)				
	Code	K	J	U	G
Supply voltage / ripple	[V]	12 V =	24 V =	98 V =	205 V =
Tolerance supply voltage	[%]	±10	±10	±10	±10
Current consumption hold	[A]	3	1.5	0.35	0.18
Power consumption hold	[W]	36	36	34	36
Solenoid connection	Connector as per EN 175301-803, solenoid identification as per ISO 9461.				
Wiring min.	[mm ²]	3 x 1.5 recommended			
Wiring length max.	[m]	50 recommended			

With electrical connections the protective conductor (PE \perp) must be connected according to the relevant regulations.

Ordering Code Single Solenoid Valve

2

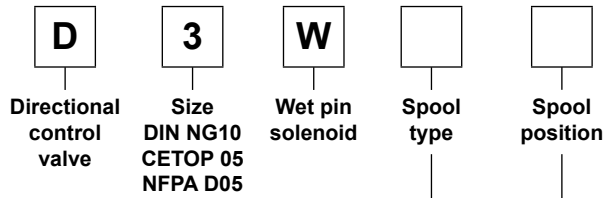

3 position spools	
Code	Spool type
	a 0 b
001	
002	
003 ¹⁾	
004	
005 ²⁾	
015 ²⁾	
016 ¹⁾	
021 ¹⁾	
022 ²⁾	

2 position spools	
Code	Spool type
	a b
020	
026	
030	

3 position spools		
Code	Spool position	
E		2 positions. Spring offset in position "0". Operated in position "a".
F		2 positions. Spring offset in position "b". Operated in position "0".
K		2 positions. Spring offset in position "0". Operated in position "b".
M		2 positions. Spring offset in position "a". Operated in position "0".

2 position spools		
Code	Spool position	
B		2 positions. Spring offset in position "b". Operated in position "a".
H		2 positions. Spring offset in position "a". Operated in position "b".

¹⁾ Only available for spool pos. "K" and "M".
²⁾ Only available for spool pos. "E" and "F".
³⁾ To be used in combination with rectifier plugs at 120 VAC / 230 VAC power supply.
⁴⁾ Please order female connector M12x1 separately (see accessories, female connector M12x1 (order no.: 5004109)).
⁵⁾ For hydraulic presses according to the safety regulations DIN EN ISO 16092-3, solenoid option "T" (without manual override) and accessories "14" or "15" (start position monitored) are required.

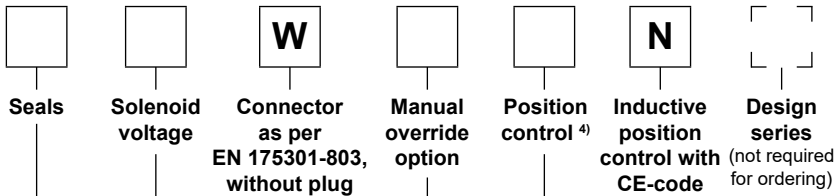

Code	Position control	Spool position
I2	End position monitored side B	E, F, B (Solenoid on a-side)
I5 ⁵⁾	Start position monitored side B	
I1	End position monitored side A	K, M, H (Solenoid on b-side)
I4 ⁵⁾	Start position monitored side A	

Code	Solenoid option
omit	manual override (Standard)
T ⁵⁾	without manual override

Code	Solenoid voltage
K	12 V =
J	24 V =
U ³⁾	98 V =
G ³⁾	205 V =

Code	Seals
N	NBR
V	FPM

Further spool types and solenoid voltages on request.

Ordering Code Double Solenoid Valve

2

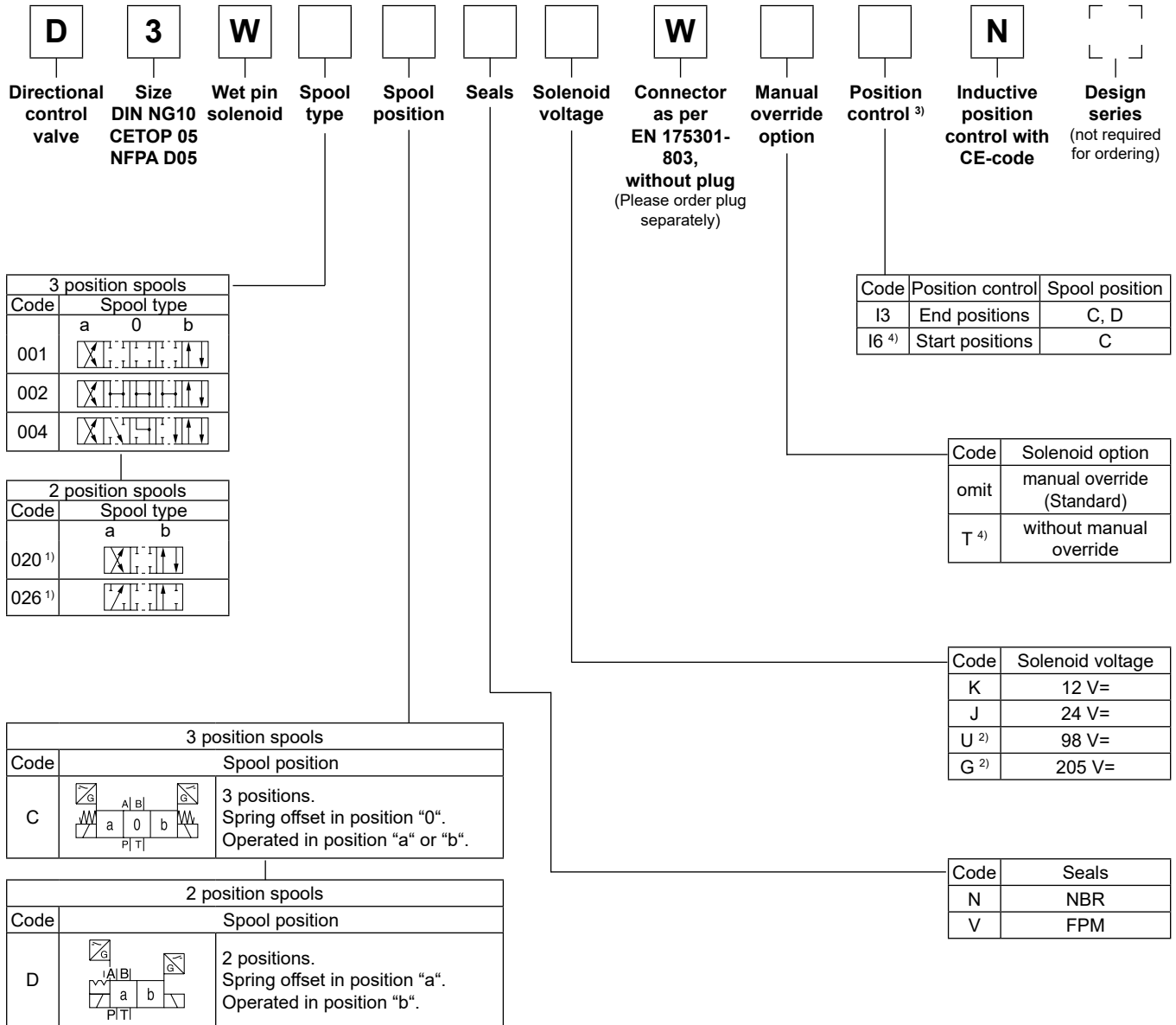

Further spool types and solenoid voltages on request.

¹⁾ Only available for end position control code "I3".
²⁾ To be used in combination with rectifier plugs at 120 VAC / 230 VAC power supply.
³⁾ Please order plug M12 x 1 separately. Straight plug recommended – no defined position possible for angled plug.
⁴⁾ For hydraulic presses according to the safety regulations DIN EN ISO 16092-3, solenoid option "T" (without manual override) and accessory "I6" (start positions) is required.

Single solenoid valve

Electrical characteristics of position control as per IEC 61076-2-101 (M12x1)

Supply voltage	[VDC]	24
Tolerance supply voltage	[%]	±20
Ripple supply voltage	[%]	≤10
Polarity protection	[V]	300
Current consumption without load	[mA]	≤20
Switching hysteresis	[mm]	<0.06
Max. output current per channel, ohmic	[mA]	250
Ambient temperature	[°C]	-20 ... +60
Protection		IP65 acc. EN 60529 (with correctly mounted plug-in connector)
Min. distance to next AC solenoid	[m]	0.1
Interface		M12x1 to IEC 61076-2-101
CE conform		EN 61000-4-2 / EN 61000-4-4 / EN 61000-4-6 ¹⁾ / ENV 50140 / ENV 50204

¹⁾ Only guaranteed with screened cable and female connector

M12 pin assignment

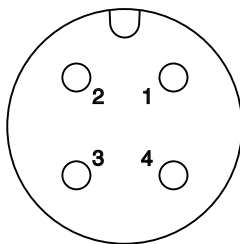

- 1 + U_s 19.2...28.8 V
- 2 Out B: normally open
- 3 0V
- 4 Out A: normally closed

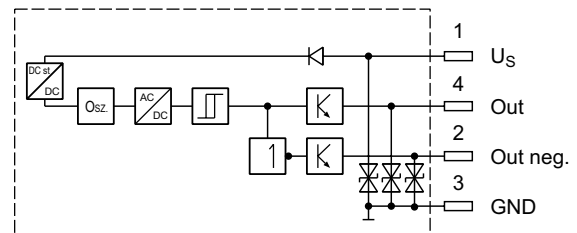

Outputs: Open collector

Definitions

Start position monitored:

The valve is de-energized. The inductive switch gives a signal at the moment when the spool leaves the spring offset position (below 15 % spool stroke).
 At the switching point the spool is located within the closed position. It is secured that only the flow paths of the offset position are granted.

End position monitored:

The inductive switch gives a signal before the end position is reached (above 85 % spool stroke).

The switch can only be located on the opposite side of the solenoid for direct operated valves. Please order plug M12x1 separately (see accessories, plug M12x1; order no.: 5004109).

Position Control

Double solenoid valves

Electrical characteristics of position control as per IEC 61076-2-101 (M12x1)

Protection class	IP65 in accordance with EN 60529 (with correctly mounted plug-in connector)	
Ambient temperature	[°C]	-20...+60
Supply voltage U_s / ripple	[V]	10...30 / ± 10 %
Current consumption without load	[mA]	≤ 10
Max. output current per channel, ohmic	[mA]	200
Min. output load per channel, ohmic	[kOhm]	100
Max. output drop at 0.2 A	[V]	≤ 2
EMC	EN61000-6-4 / EN61000-6-2	
Min. distance to next AC solenoid	[m]	> 0.1
Interface	M12x1 acc. to IEC 61076-2-101	
Wiring min.	[mm ²]	3 x 0.14 braided shield recommended
Wiring length max.	[m]	50 recommended

2

M12 pin assignment

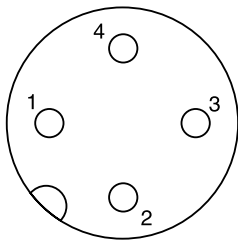

- 1 U_s 10...30 V
- 2 not connected
- 3 0 V
- 4 Out A: normally open

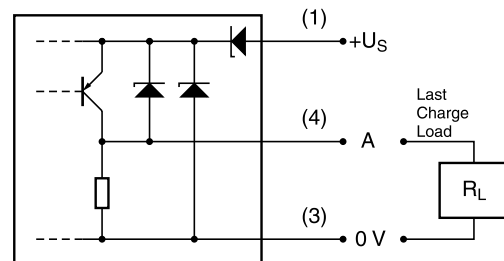

Definitions

Start position monitored:

The valve is de-energized. The inductive switch gives a signal at the moment when the spool leaves the center position (below 15 % spool stroke).

At the switching point the spool is located within the closed position. It is secured that only the flow paths of the offset position are granted.

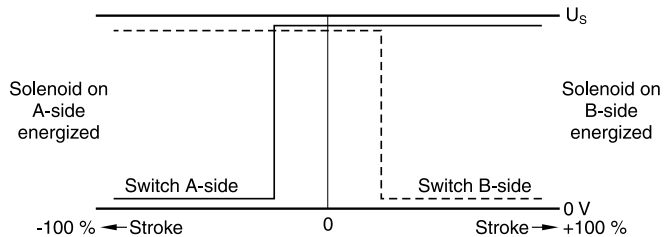

End position monitored:

The inductive switch gives a signal before the end position is reached (above 85 % spool stroke).

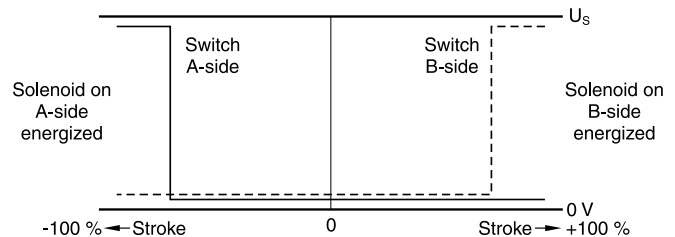

Please order plug M12 x 1 separately. Straight plug recommended – no defined position possible for angled plug.

The flow curve diagram shows the flow versus pressure drop for each spool type, operating position and flow direction is given in the table below.

Spool	Position b		Position a		Position 0					
	P->A	B->T	P->B	A->T	P->A	P->B	A->T	B->T	P->T	A->B
001	6	5	6	6	-	-	-	-	-	-
002	3	5	3	3	1	1	4	5	1	6
003	2	2	3	1	-	-	3	-	-	-
004	5	4	4	4	-	-	8	8	-	9
005	2	2	2	2	3	-	-	-	-	-
015	2	1	2	2	-	-	-	3	-	-
016	2	2	1	2	-	2	-	-	-	-
020	6	6	5	7	-	-	-	-	-	-
026	5	-	5	-	-	-	-	-	-	-
030	4	5	3	5	-	-	-	-	-	-
	Position b			Position a						
	P->A	P->B	A->B	P->B	A->T					
021	2	4	8	3	2					
	P->A	B->T			P->A	P->B	A->B			
	022	3	2	3	2	8				

2

Flow curve diagram

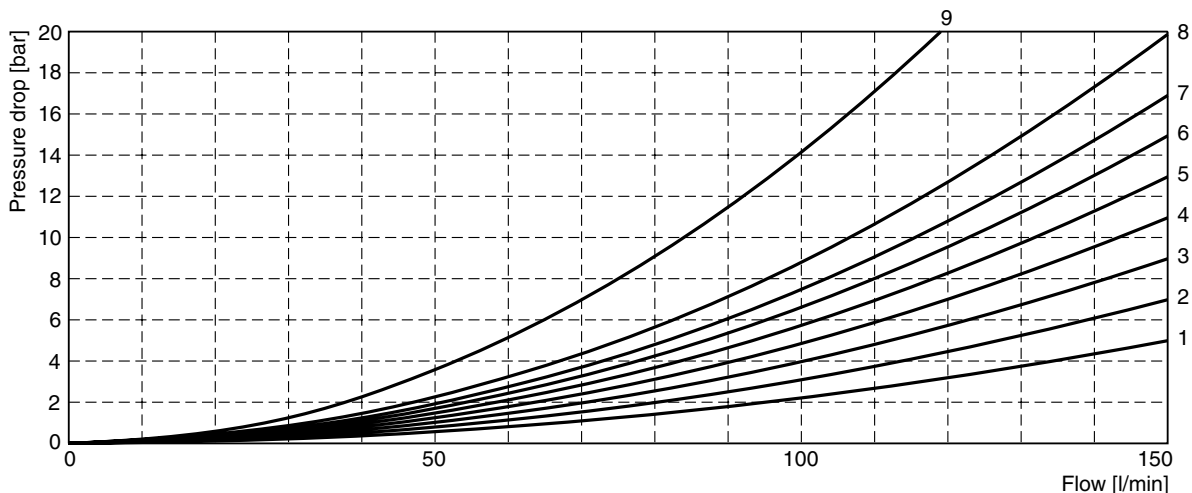

All characteristic curves measured with HLP46 at 50 °C.

Shift limit diagram

The diagram below specifies the shift limits. Valves with spool position “F” or “M” can only be operated up to 70 % of the limits. The specifications apply to a viscosity of 40 mm²/s and balanced flow conditions. The shift limits can

be considerably lower at unbalanced flow conditions. To avoid flow rates beyond the shift limits, a plug-in orifice can be inserted in the P-port.

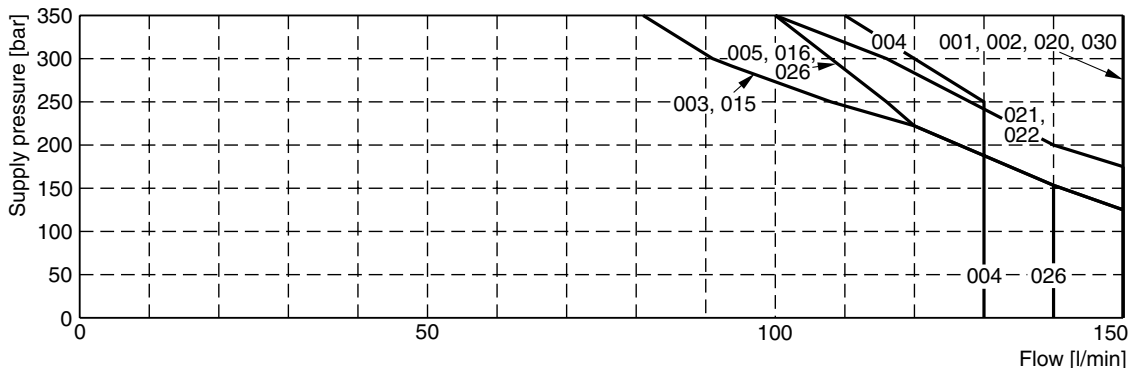

Measured with HLP46 at 50 °C, 90 % U_{nom} and warm solenoids.

Dimensions

Interface EN 175301-803, DC solenoid, without plug M12x1¹⁾ B, E, F -style

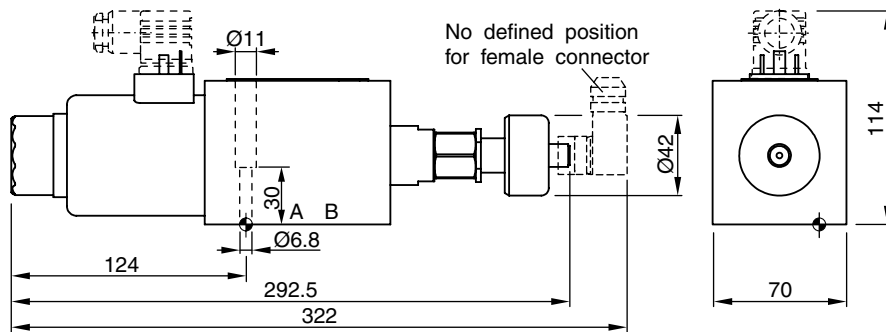



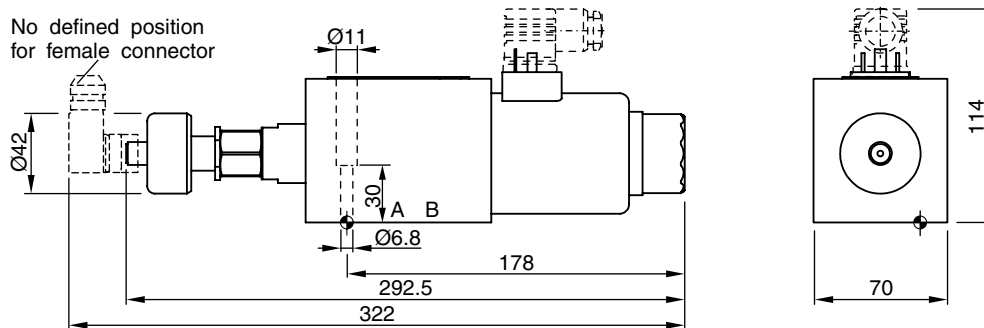

H, K, M -style

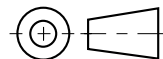
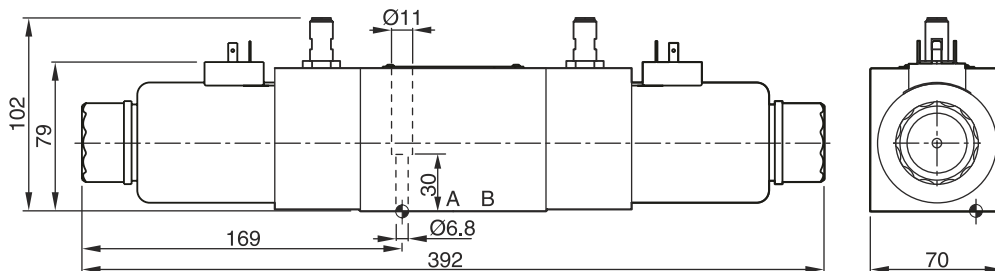

Interface EN175301-803, DC solenoid, without plug M12x1²⁾ C, D -style

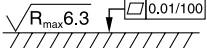

Surface finish	 Kit	 Kit	 Kit	 Kit
	BK385	4x M6x40 ISO 4762-12.9	13.2 Nm ±15 %	NBR: SK-D3W-30 FPM: SK-D3W-V-30

The space necessary to remove the plug per EN 175301-803, design type AF is at least 15 mm.

The torque for the screw M3 of the plug has to be 0.5 to 0.6 Nm.

The space necessary to remove the M12x1 female connector is at least 22 mm.

Attention:

The adjustment of the position control is factory set and sealed. Replacement and repairs can only be undertaken by the manufacturer.

¹⁾ Please order plug M12x1 separately (see accessories, plug M12x1; order no.: 5004109).

²⁾ Please order plug M12x1 separately. Straight plug recommended - no defined position possible for angled plug.